

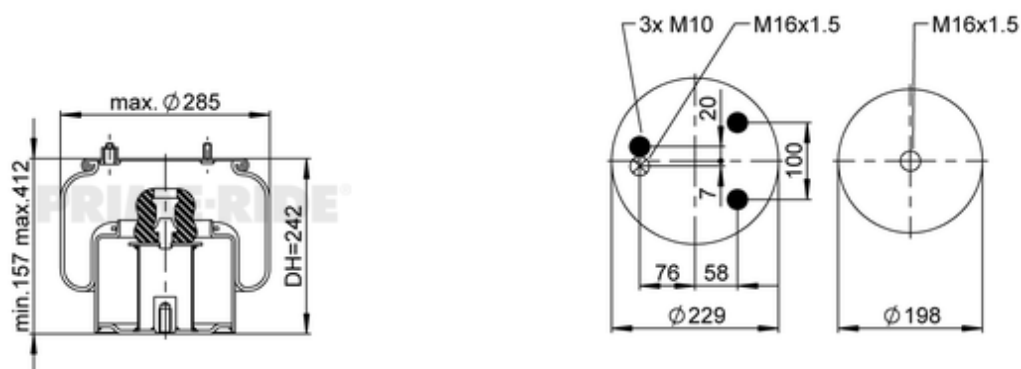





1R11-797

20921076



-  bolt or stud
-  hole
-  combination stud
-  air inlet

 kg	7,6 kg
	
	M10: max. 30 Nm
	M16: max. 90 Nm
	M16x1.5: max. 90 Nm

OE Manufacturer/Part No.

Manufacturer	Original Part No.	Model
VDL Bus	1 154 761	
VDL Bus	41 141 525	
DAF	1 141 525	