

1R11-826

20920791

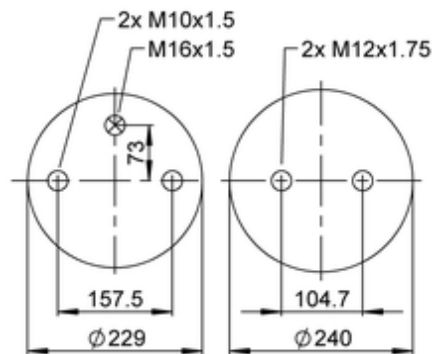

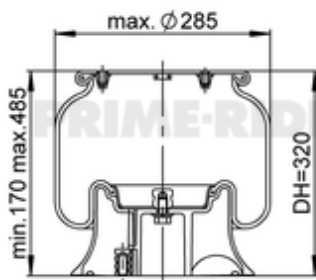



● bolt or stud

○ hole

⊗ combination stud

⊗ air inlet

 kg	5,7 kg
	
	M10: max. 40 Nm
	M12x1.75: max. 60 Nm
	M16x1.5: max. 90 Nm

## OE Manufacturer/Part No.

Manufacturer	Original Part No.	Model
Scania	1314903	
Scania	1394997	
Scania	1402423	
Scania	1865759	Scania P,R,T
Scania	2517987	Scania P,R,T

