

1R12-837

20920739

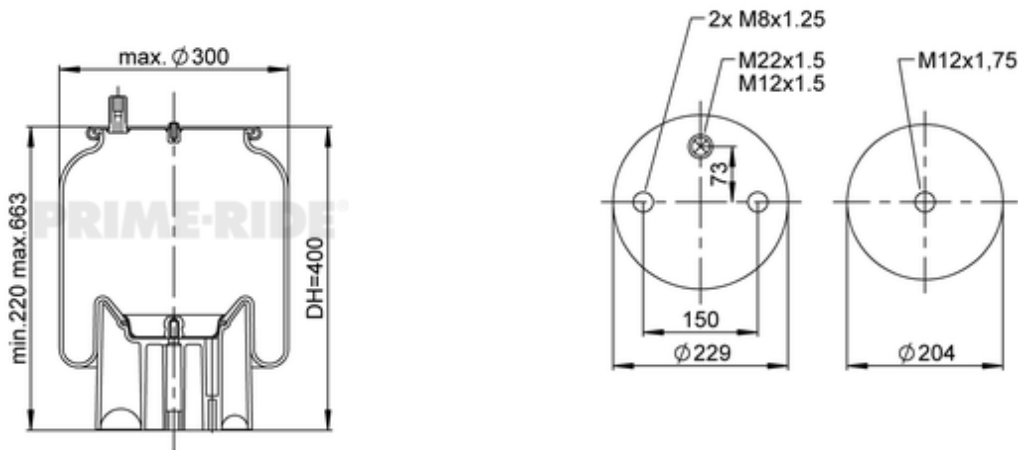







● bolt or stud

○ hole

⊗ combination stud

⊗ air inlet

 kg	6 kg
	
	M12x1.5: max. 20 Nm
	M12x1.75: max. 45 Nm
	M22x1.5: max. 70 Nm
	M8: max. 25 Nm

OE Manufacturer/Part No.

Manufacturer	Original Part No.	Model
Weweler	US 86318F	
WEWELER	US 86318	
WEWELER	US06318F	
SCHMITZ	5016512	
SCHMITZ	16512	

SCHMITZ	1244666
SCHMITZ	1270603
SCHMITZ	016512
SCHMITZ	016588