

1R12-899

20958073

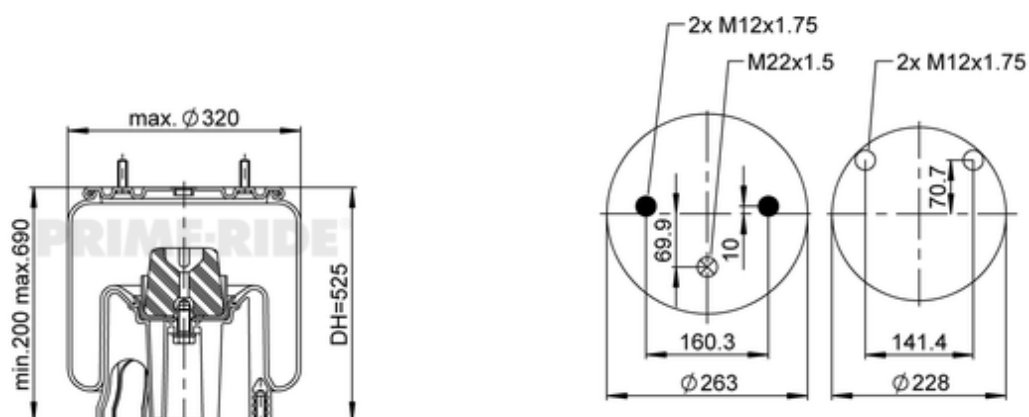

● bolt or stud

○ hole

⊗ combination stud

⊗ air inlet

	8,2 kg
	M12x1.75: max. 66 Nm
	M22x1.5: max. 70 Nm

## OE Manufacturer/Part No.

Manufacturer	Original Part No.	Model
SCHMITZ	1111841	
SCHMITZ	1336402	